



RETRACTABLE SECURITY GATES
SECEUROGUARD™

SecuroGuard 1001 Insurance Approved Retractable Security Gates

SECEUROGUARD™ 1001



INSURANCE APPROVED

The SecuroGuard 1001 Retractable Security Gate offers an outstanding mix of security with the elegance of the lattice style design. The SecuroGuard 1001 is SWS's Insurance Approved design. Approval has been gained as a result of independent testing to Loss Prevention Standard (LPS) 1175 Security Rating Classification 1. The remainder of this section covers the background to what this approval and rating means in practical terms.

REMOVING THE GUESSWORK FROM PRODUCT EVALUATION AND SELECTION

How can you know which products are truly resistant to physical attack? Appearance may suggest security, but can you be sure that a device does not contain a design flaw that will allow rapid access to the ingenious burglar? Specifiers, end-users, the police and insurers are increasingly demanding physical security products that carry an independent stamp of compliance and quality assurance.

TESTED AND APPROVED TO LPS 1175

The Loss Prevention Certification Board (LPCB), the UK's leading independent certification body for fire and security products, operates an approval scheme to LPS 1175. Approval and certification is based on the testing of a product's performance and the manufacturer's quality management systems being in accordance with ISO 9002. Installation procedures are also defined to a high standard, ensuring the product performance is not compromised by sub-standard installation. These specialist products should only be attached to structurally sound openings such as masonry, brick, steel or timber, moreover the type and frequency of fixings required is very precise. LPS 1175 is the only meaningful benchmark for gauging actual resistance in the face of a determined attack.

Passing the test regime is a tough and lengthy process that has been successfully completed by the SecuroGuard 1001. Under the stringent conditions of a comprehensive test regime, SecuroGuard 1001 is subjected to a variety of assaults from equipment commonly used for vandalism and breaking and entering, in order to ascertain its burglary resistance to physical attack.

LPCB approval and certification gives assurance of the SecuroGuard 1001's construction and consistent performance to an internationally recognised standard.

Take the guesswork out of product selection - use tested and approved products from SWS.

THE POLICE PREFERRED SPECIFICATION

As a further reinforcement of the products performance, the SecuroGuard 1001 retractable security gate has successfully undergone Secured by Design evaluation and is able to display the "Police Preferred Specification" mark. Secured by Design identifies technical standards and evaluations which test the competence of security products and their resistance to criminal attack. The tests and evaluations are carried out by UKAS approved test houses.



SecuroGuard 1001 undergoing a simulated attack test



SecuroGuard 1001 Security Gates - excellent security with vision, fixed here behind a window arch.

SECEUROGUARD 1001

The SecuroGuard retractable security gate system combines a classic appearance with effective protection, ideal for home or workplace. The high security 1001 has added structural strength from a specially designed lattice assembly system using high patented grade steel inter-screws.

The system can be fitted to the face or reveal of a window or door aperture and can be specified in a single or double-sash configuration. Where a clear, safe walk through is required SecuroGuard's bottom track can, as an optional extra, be made to fold up.

FOR RESIDENTIAL PREMISES

In high risk areas or simply for added peace of mind, the SecuroGuard 1001 is an excellent choice for home protection. With added structural strength combined with many of the features of the SecuroGuard 1000, the SecuroGuard 1001 offers stylish, unobtrusive security alongside potential insurance premium benefits.





Vision and light levels are excellent - **now you see it**



...**now you don't**



Effective protection for business



Standard 'X' Lattice

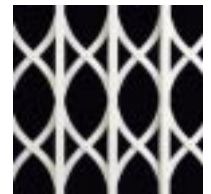

'S' Lattice Option



Folding Bottom Track Option

FOR RETAIL PREMISES

The added security and strength of the insurance approved SeceuroGuard 1001 offers effective protection of high value stock in window and store displays. Combining many of the features of the SeceuroGuard 1000 with increased structural strength and, in most cases, 4 point locking, the SeceuroGuard 1001 has optional folding bottom tracks to allow unrestricted access through doorways when the gates are open and compact sashes which fold neatly to the side giving unobscured visibility of window displays.

FOR BUSINESS PREMISES

Businesses in vulnerable locations or premises containing valuable equipment are often targeted by criminals. Either on an insurance company's recommendation, or to pre-empt future attack, the insurance approved SeceuroGuard 1001 is the perfect choice. Offering enhanced strength and security with minimal obstruction to visibility and natural light even when the gates are in the closed position, premises and staff are protected with no detractor to the appearance of the office environment.

SECEUROGUARD 1001

HIGH PERFORMANCE SECURITY, NO SACRIFICE IN APPEARANCE

- **Strong** - Made from galvanised steel with a patented fixing system
- **Versatile** - Custom built for almost any opening, gates fit internally in either the window reveal or around the opening in either single or double-sash configuration
- **Ease of use** - Smooth top running operation with an option of a folding bottom track to leave doorways unobstructed
- **Secure** - Multi-point locking (4 point in most cases, with three point on smaller gates) operating from a single key which is out of view of potential attackers whilst remaining easy to operate from either side
- **High quality maintenance free finish** - Supplied in high quality white powder coated finish as standard. Optional colours are available from stock
- A floating sash version is available
- A fixed frame version is available when retraction of the gate is not required

When extra security and strength is needed, SeceuroGuard 1001 is the insurance approved option. Stylish, yet deceptively strong, unobtrusive, essentially maintenance free and easy to use, the SeceuroGuard 1001 offers LPCB certified and approved protection.

SeceuroGuard 1000 Retractable Security Gates

SECEUROGUARD™ 1000

AN EFFECTIVE BARRIER AND DETERRENT TO CRIME

The SeceuroGuard Retractable Security Gate system is a stylish solution for protecting windows and doors. The SeceuroGuard 1000, the standard design, offers security combined with through-vision.

When protection is needed, SeceuroGuard 1000 acts as a visible deterrent to would be intruders who, should they persist, will meet with an effective barrier to entry. When not in use, SeceuroGuard 1000 is unobtrusive and compact. The sashes fold neatly to the side, out of sight behind curtains or vertical blinds, with the option of fold away bottom tracks to leave openings unrestricted.

Reliable, quick and easy to use, maintenance free with multi point locking and galvanised for corrosion resistance, the SeceuroGuard 1000 offers effective yet flexible security.



Security and deterrent



Quick and easy operation. Bunching to the side, the gates are concealed behind the curtains when open

MATCHING STYLE WITH STRENGTH

FOR RESIDENTIAL PREMISES

Elegant good looks with a heart of steel - the SeceuroGuard 1000 Retractable Security Gate System combines a classic appearance with strength, making it an ideal security choice for the home.

Designed to keep intruders out while letting maximum light in, they are perfect for patio doors, French windows and any other vulnerable ground floor doors or windows. Gates can be left locked with doors open to provide ventilation without loss of security.

When not in use these retractable gates are surprisingly unobtrusive. Fitted to the door or window surround, they can disappear neatly behind curtains and a pelmet can be used to conceal the top track.

The gates offer the option to remove the bottom guide track from the opening and sashes may be hinged to swing to the side at 90° or up to 270° leaving French windows and doorways free from obstruction. (The hinge aside option requires a folding bottom track).

Essentially maintenance free, each SeceuroGuard 1000 is available in a range of powder coated colour options to complement your decor, and can also be supplied with optional decorative 'S' Profile lattices.



Excellent light levels when closed

VISIBLE DETERRENT, VISIBLE STOCK

FOR RETAIL PREMISES

Installed inside a shop window, SeceuroGuard 1000 retractable gates deliver an exceptionally strong yet aesthetically appealing barrier against intruders, which allows merchandise to be displayed safely, 24 hours a day. Products stay on display with unrestricted visibility and yet remain protected.

Fitted at the rear of a window display, retractable gates also effectively create an attractive backdrop whilst protecting the shop's interior. The window display view remains totally uninterrupted whilst the gate is accessible for easy operation.

SeceuroGuard 1000 retractable gates are safe, easy to handle, smooth and quiet to operate. They hang from a top track with a guide track at the base which, as an optional extra, can be supplied to quickly fold up when not required, leaving shop entrances free from obstruction and aid disabled access.

Being fully retractable, when not required, each sash can be folded neatly in the open position away from the door or window openings. Optionally, gates may be hinged to swing away from the opening at 90° or up to 270° to provide a completely clear opening (hinge aside option requires a folding bottom track).



'S' Lattice design

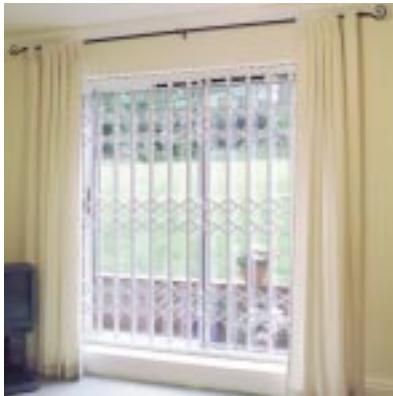

Perfect for protecting vulnerable patio doors



Slide the sash aside for an uninterrupted view



Standard 'X' Lattice

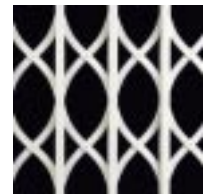

'S' Lattice Option



Optional Folding Bottom Track



The hinge side option ensures a totally clear view (The hinge side option requires a folding bottom track)



Protecting valuable stock

Retail installations still permit product display

SECURE YET UNOBTRUSIVE

FOR COMMERCIAL PREMISES

Allowing maximum natural light into commercial premises, retractable gates fold to the sides of the window reveal when not required and can be concealed neatly behind vertical blinds to create a secure but pleasant working environment.

Office premises, staff and equipment are safely protected by an exceptionally strong security barrier, manufactured from pre-galvanised rolled steel with multi point locking from a single key.

Offering security features which are particularly important on vulnerable ground floor windows and doors, the SeceuroGuard 1000 ensures excellent barrier security. Whilst the top hung ultra-smooth carrier system and nylon coated steel bearings also ensure it is quick and easy to open and close.

SeceuroGuard 1000 is essentially maintenance free and available in a broad range of optional powder coated colours to complement corporate styling.

SECEUROGUARD 1000

CLEAR BENEFITS

Essentially maintenance free with a wide range of colour options and a choice of lattice styles, classic appearance and convenience combine with the high levels of protection.

- Strong security barrier and deterrent
- Galvanised for corrosion resistance and powder coated
- Fully retractable system
- Excellent through-vision and ventilation when locked
- Multi-point locking (2 point) from a single key
- Smooth running carrier system ensures quick and easy operation
- Custom built for almost any opening
- An unlimited width can be accommodated in sections
- A floating sash version is available
- A fixed frame version is available when retraction of the gate is not required

Exceptionally strong, yet unobtrusive and stylish, the SeceuroGuard 1000 will transform the way you protect your property.

Specification

SECEUROGUARD™ 1001 Insurance Approved Specification

GENERAL ARRANGEMENT

- 1 Top hung on nylon coated steel bearings
- 2 All galvanised steel construction
- 3 Powder coating in a range of colours
- 4 Fits within or around the reveal
- 5 4 point locking from a single key with the lock mechanism shielded by a steel plate
- 6 Strong steel lattice with smooth durable finish
- 7 Overlapped locking profiles
- 8 Optional folding bottom track
- 9 The 1001 has a specially designed lattice assembly system utilising high grade steel screws (patented).

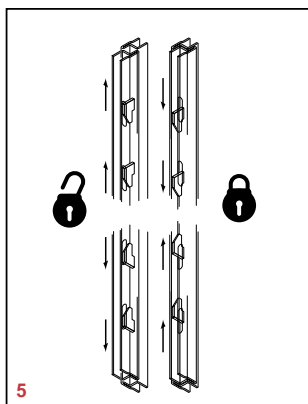

'X' Lattice

'S' Lattice

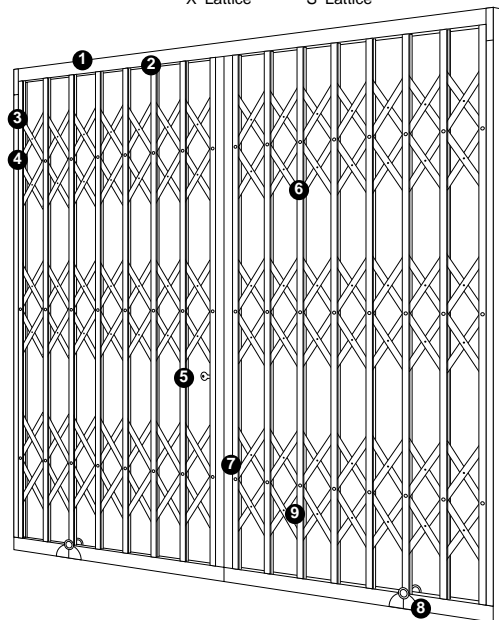

1001 INSTALLATION CRITERIA

The validity of the LPCB certification is contingent upon each security gate being installed in accordance with the requirements of LPS 1175.

● Reveal or face installation	
● Min fixing distance from edge of reveal	50mm
● Max fixing distance from any corner	100mm
● Max distance between fixing	400mm
● All fixing heads spoiled:	
Masonry	2.5" x 12s
Wood	4.0" x 12s
Steel	1.0" x M8s

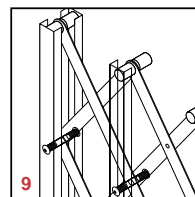
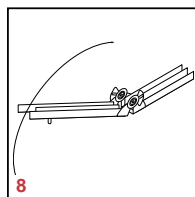
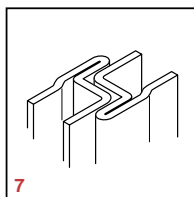
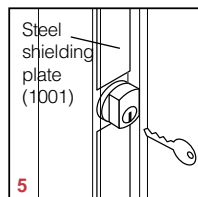
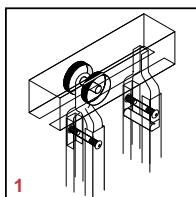

Note - All approved gates carry a label detailing the manufacturer, test standard and rating.

SECEUROGUARD™ 1000 Specification

GENERAL ARRANGEMENT

- 1 Top hung on nylon coated steel bearings
- 2 All galvanised steel construction
- 3 Powder coating in a range of colours
- 4 Fits within or around the reveal
- 5 Multi-point locking from single key - 2 point
- 6 Strong steel lattice with smooth durable finish
- 7 Overlapped locking profiles
- 8 Optional folding bottom track
- 9 Steel riveted lattice assembly system.

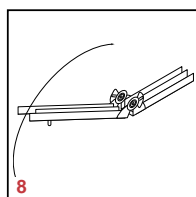
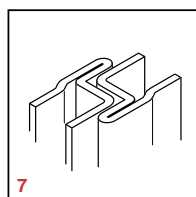
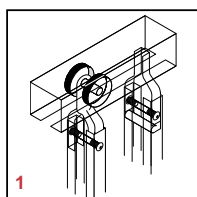
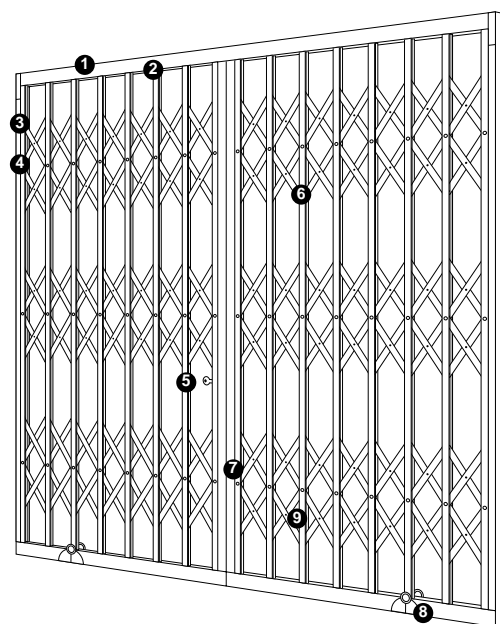
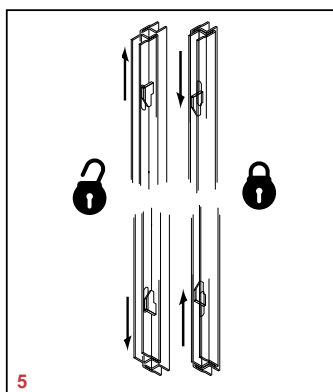

BUNCH SIZES (MM)

OVERALL GATE WIDTH 'A'	SINGLE SASH		DOUBLE SASH	
	SINGLE SASH BUNCH 'B'	CLEAR OPENING WIDTH 'C'	DOUBLE SASH PER BUNCH 'D'	CLEAR OPENING WIDTH 'E'
mm	mm	mm	mm	mm
500	135	315		
600	135	415		
700	150	500		
800	165	585		
900	180	670		
1000	180	770	135	730
1100	195	855	135	830
1200	210	940	150	900
1300	225	1025	150	1000
1400	225	1125	150	1100
1500	240	1210	165	1170
1600	255	1295	165	1270
1700	270	1380	180	1340
1800	285	1465	180	1440
1900	285	1565	180	1540
2000	300	1650	195	1610
2100	315	1735	195	1710
2200	330	1820	195	1810
2300	330	1920	210	1880
2400	345	2005	210	1980
2500	360	2090	225	2050
2600	375	2175	225	2150
2700	375	2275	225	2250
2800	390	2360	240	2320
2900	405	2445	240	2420
3000	420	2530	255	2490
3100	435	2615	255	2590
3200	435	2715	255	2690
3300	450	2800	270	2760
3400	465	2885	270	2860
3500	480	2970	270	2960
3600	480	3070	285	3030
3700	495	3155	285	3130
3800	510	3240	300	3200
3900	525	3325	300	3300
4000	525	3425	300	3400
4100	540	3510	315	3470
4200	555	3595	315	3570
4300	570	3680	330	3640
4400	585	3765	330	3740
4500	585	3865	330	3840
4600	600	3950	345	3910
4700	615	4035	345	4010
4800	630	4120	345	4110
4900	630	4220	360	4180
5000	645	4305	360	4280
5100	660	4390	375	4350
5200	675	4475	375	4450
5300	675	4575	375	4550
5400	690	4660	390	4620
5500	705	4745	390	4720
5600	720	4830	405	4790
5700	735	4915	405	4890
5800	735	5015	405	4990
5900	750	5100	420	5060
6000	765	5185	420	5160

Please note: The clear opening widths detailed above apply to retractable gates with fixed tracks. If the gate requires folding bottom tracks or the hinge aside option (with or without folding bottom tracks) you will need to add 60mm per bunch to the bunch sizes above.

***Please ask for details on widths greater than 6m**

SECURITY GATES BUNCH SIZES

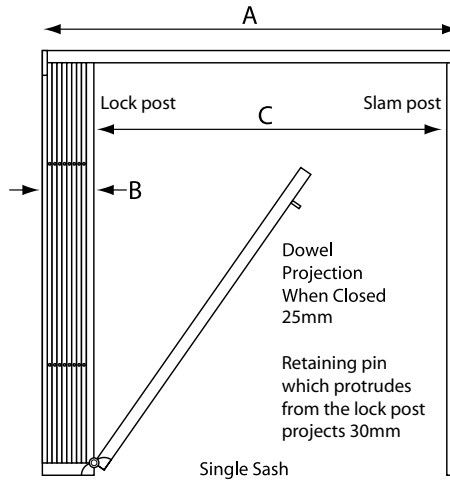

Note: All clear opening sizes for single sash gates allow for the slam post. For hinge aside gates the bunch size is increased by a further 30mm per sash

Note: Folding tracks with a length of 600mm or more are supplied with a retaining pin as standard. This is located between 488mm and 568mm from the ground regardless of track length. **The retaining pin projects 60mm beyond the lock post when the track is lowered and 30mm when raised.** If the width of the gate is greater than the height check that there will be sufficient room for the bottom track to fold up into.

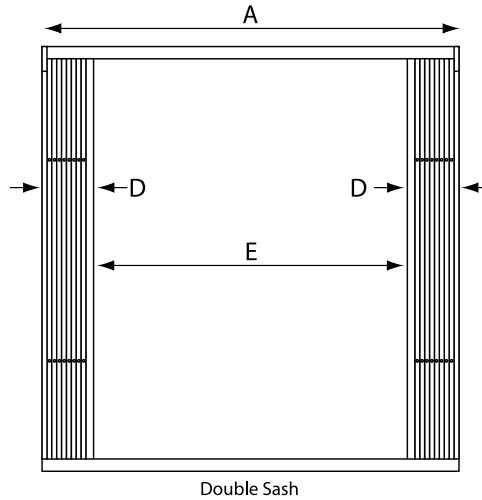

Double Sash

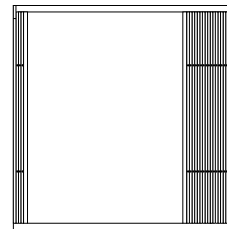

Uneven Sashes On double sash gates, the sashes can be split with the majority opening to one side, useful where there is a preference or a limited space at one side of the aperture to accommodate the retracted sash.

SIZES

1001		
Sizing	Single Sash	Double Sash
Min Width	500	1000
Min Height	1000	1000
Max Width	3000	6000
Max Height	3000	3000

1000		
Sizing	Single Sash	Double Sash
Min Width	350	700
Min Height	500	500
Max Width	*3000	*6000
Max Height	3500	3500

WEIGHT
19kgm²

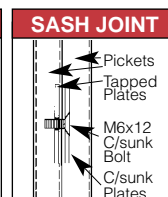

LOCK HOOKS	
Gate Height Range (mm)	Number of lock hooks available
1000+	2 (4 optional)
1000-500	2
500-350	Fixed Panel

***NOTE: SeceuroGuard 1000** can accommodate an unlimited width with multiple sashes. Sashes are made in single pieces up to 2m wide. Larger sizes are made in sections for assembly on site, ensuring the weight of each section can be handled safely. Gates which are wider than 4m will be supplied with the top track in two pieces, the split will be in the middle. Where two split sashes meet two pickets are joined together using bolts and fixing plates supplied loose (see illustration above).

Specification

TERMINOLOGY

The following lists the preferred terminology applied to SeceuroGuard gates (in Bold) and alternatives which are also in common use:

SASH	- Bunch / Stack / Hand
TOP TRACK	- Top runner / Top Rail / Top Guide
FOLDING TRACK	- Lift up / Hinge (should not be used -can be confused with the hinge aside option)
REMOVABLE TRACK	- Lift Out / Lift Off
HINGE ASIDE	- Hinging Sash / Swinging Sash / Fold Back
C-SIDE FIXING FRAME	- C-Side / Reinforcing for Top Track / Strengthening for Top Track
REVEAL FIXED	- Between Walls / Recess
FACE FIXED	- Surface Mounted / Plant On
BI-PARTING	- Double / Double Draw / Split
KEYED ALIKE	- Suited / Same
PICKET	- Upright

REVEAL FIX FRONT ELEVATION

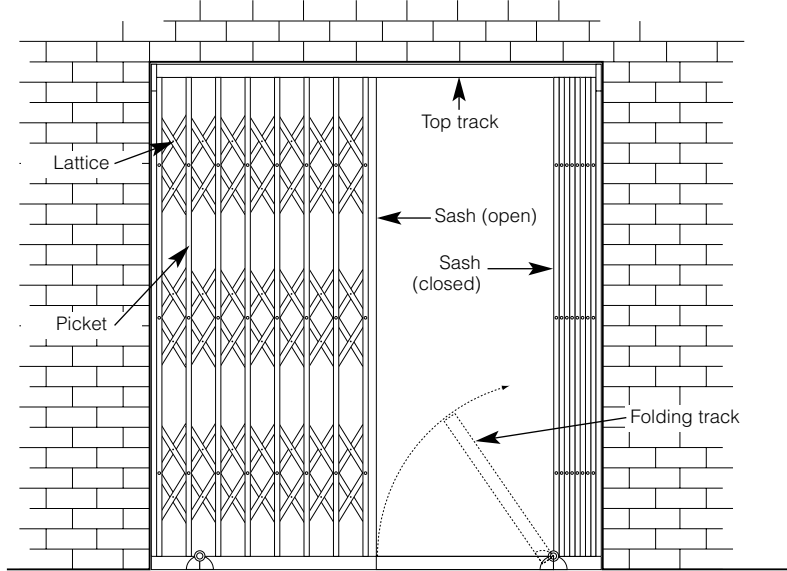

FACE FIX FRONT ELEVATION

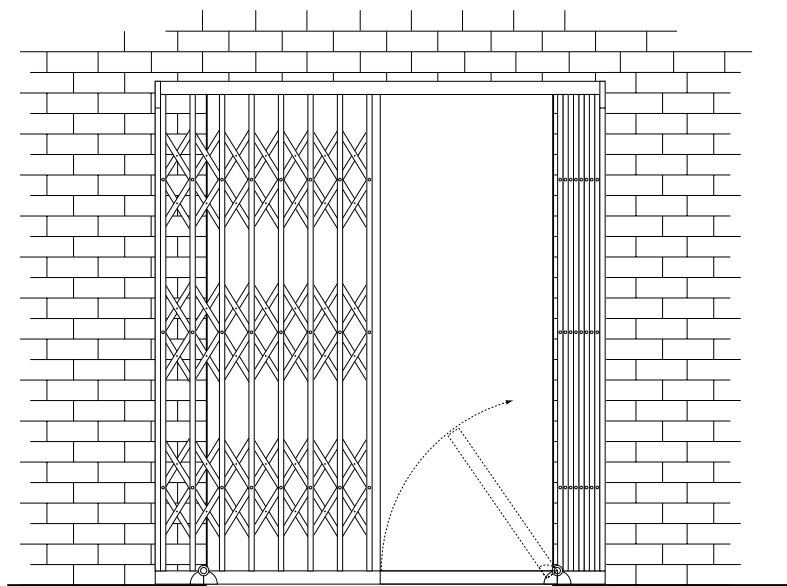

TRACK PROFILES

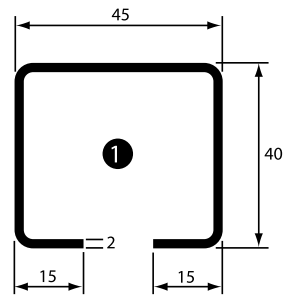

Top Track

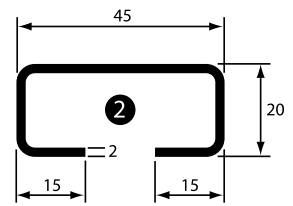

Fixing Frame

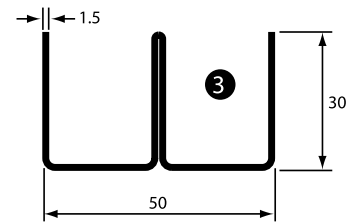

Bottom 'W' Track

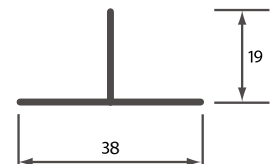

Low profile Bottom 'T' Track
Low security option SeceuroGuard 1000 only

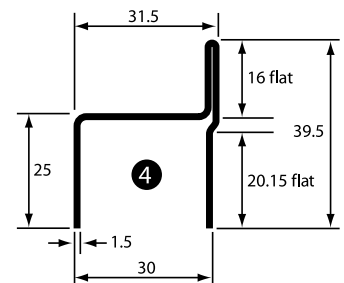

Lock Post

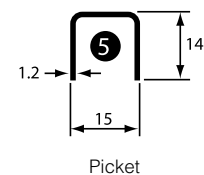

Picket



FACE FIXED SIDE ELEVATION

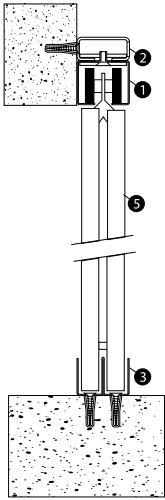

The standard arrangement for a face fitted gate is as shown with the top track and sides face fixed and the bottom track reveal fixed. When ordering please identify clearly how each side of the frame will be fitted. Importantly, the size of your order will be manufactured to a height including fixing frame(s).

FACE FIXED SIDE ELEVATION WITH PACKER

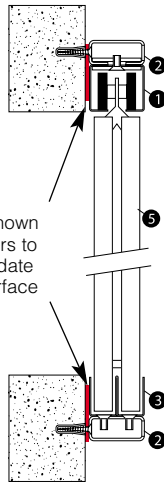

Face Fix shown with packers to accommodate uneven surface

REVEAL FIXED SIDE ELEVATION

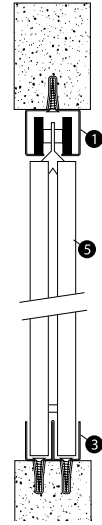

FACE FIX PLAN VIEWS & FIXING DETAILS

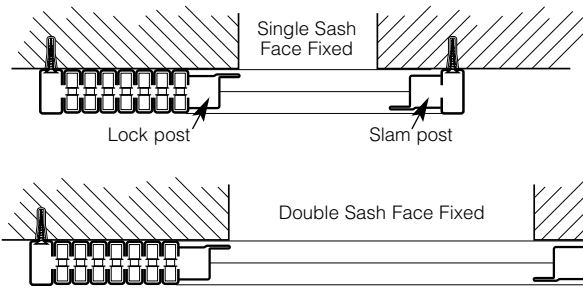

FIXING DETAIL FACE FIX

Face Fixed Side Frame

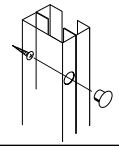

FIXING DETAIL

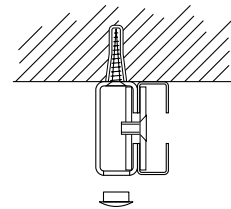

Face Fixed Side Frame Detail

REVEAL FIX PLAN VIEWS & FIXING DETAILS

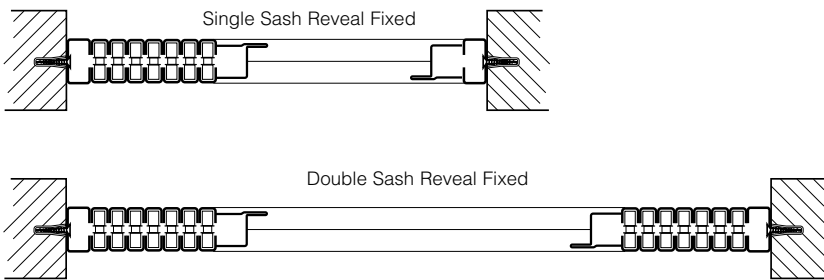

FIXING DETAIL

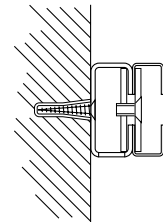

Reveal Fixed Side Frame Detail

LATTICE CONFIGURATIONS

LATTICE DESIGNS

High grade steel construction in 'X' lattice and 'S' lattice as an option.



Standard 'X' lattice



'S' lattice option

LATTICE INCREMENTS

GATE HEIGHT	NUMBER OF LATTICES
0 - 999	1
1000 - 1599	2
1600 - 2099	3
2100 - 2699	4
2700 - 3500	5

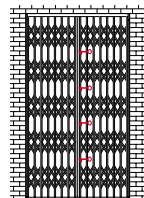
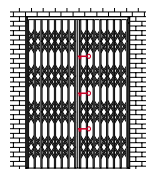
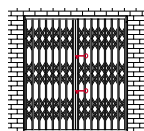
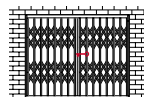
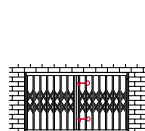

Lattice Increments with the options for lock position denoted by the key symbol

PICKET QUANTITY CHANGEOVER

Single Sash			Double Sash		
GATE WIDTH	BUNCH QUANTITY		GATE WIDTH	BUNCH QUANTITY	
500	5		1000	5	
560	6		1160	6	
690	7		1420	7	
820	8		1680	8	
950	9		1940	9	
1080	10		2200	10	
1210	11		2460	11	
1340	12		2720	12	
1470	13		2980	13	
1600	14		3240	14	
1730	15		3500	15	
1860	16		3760	16	
1990	17		4020	17	
2120	18		4280	18	
2250	19		4540	19	
2380	20		4800	20	
2510	21		5060	21	
2640	22		5320	22	
2770	23		5580	23	
2900	24		5840	24	

Specification

FLOATING SASH OPTION

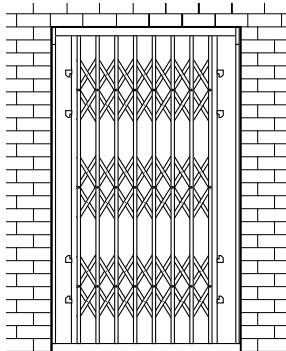

Both the 1000 & 1001 can be supplied as a floating sash. With locking to both sides of the assembly, the gates are able to bunch to either side of the opening. The design facilitates easy cleaning of windows and can improve flexibility of access.

FIXED SASH OPTION

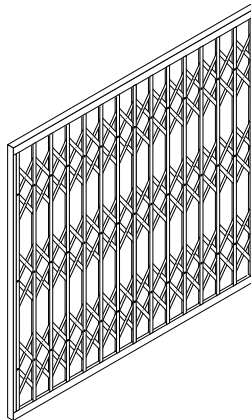

Both the 1000 & 1001 can be supplied as a fixed sash when retraction is not a requirement. This is often used as an alternative to fixed bars.

BOTTOM RUNNING OPTION

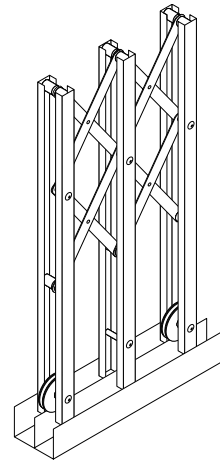

The 1000 can be supplied as a bottom running version for applications where suitable fixing points are not available at the top of the installation or for very heavy gates.

STANDARD COLOUR OPTIONS

Please note: the colours illustrated on this page are intended as a guide only.

Reference should be made to an appropriate RAL or BS chart prior to ordering. Other RAL or BS colours are available, please ask for details.

We offer the following colours in Satin unless otherwise stated:

White RAL 9010 Satin	Brilliant White RAL 9016 Satin	Magnolia RAL 1015 Satin	Mushroom BS 06 C 33 Satin	Beige RAL 1001 Satin	Yellow RAL 1018 Gloss	Orange RAL 1028 Gloss	Pale Green RAL 6021 Gloss	Green RAL 6016 Satin	Green BS 14 C 39 Satin
Moss Green RAL 6005 Satin	Fir Green RAL 6009 Satin	Pale Brown RAL 8070 Satin	Brown RAL 8014 Satin	Brown BS 08 B 29 Satin	Dark Brown RAL 8022 Satin	Poppy Red BS 04 E 53 Satin	Traffic Red RAL 3020 Satin	Dark Red RAL 3011 Gloss	Pale Blue RAL 5015 Satin
Blue RAL 5009 Satin	Royal Blue RAL 5002 Satin	Dark Blue RAL 5003 Satin	Dark Blue RAL 5013 Satin	Off White RAL 9003 Satin	Pale Grey RAL 7047 Satin	Pale Grey BS 18 B 17 Matt	Pale Grey RAL 7035 Satin	Grey BS 00 A 09 Satin	Grey RAL 9006 Satin
Grey BS 632 Satin	Dark Grey RAL 7015 Gloss	Black RAL 9005 Satin							

NON STANDARD POWDER COATING COLOURS

If you require assistance identifying or selecting a colour which does not appear on our list of stock colours we can supply you with a RAL or BS colour chart.



HINGE ASIDE OPTION DETAIL SecuroGuard 1000 Only

Maximum size for hinge aside
 1800mm x 2400mm (w x h) single sash
 3600mm x 2400mm (w x h) double sash

Please Note: SecuroGuard 1001 is **NOT** available with the hinge aside option, bottom running option, split top or bottom track or split sashes

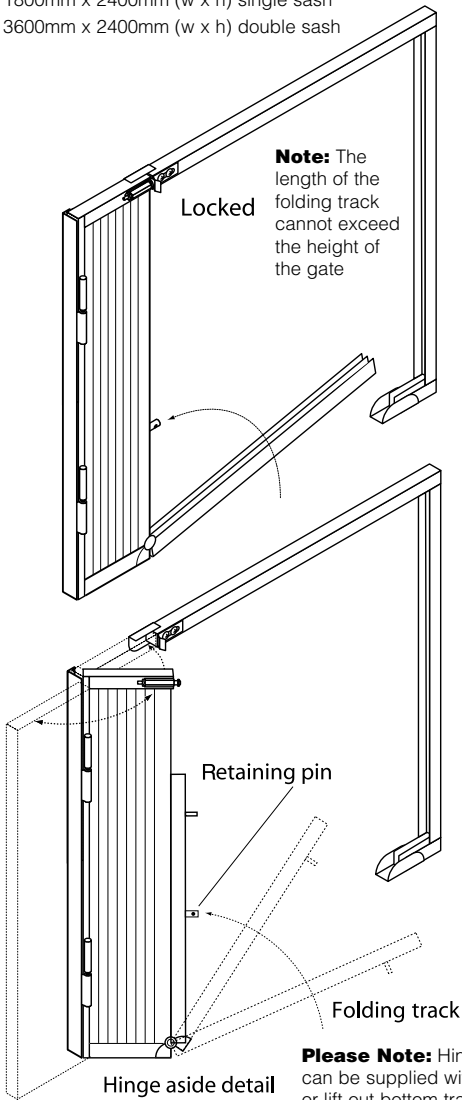

Note: Folding tracks with a length of 600mm or more are supplied with a retaining pin as standard - see below for details

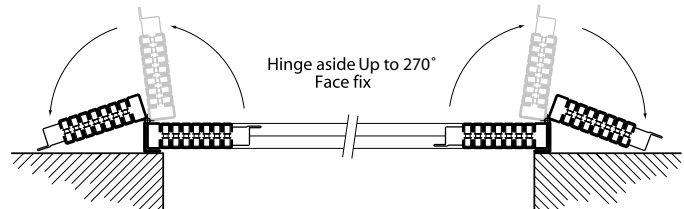
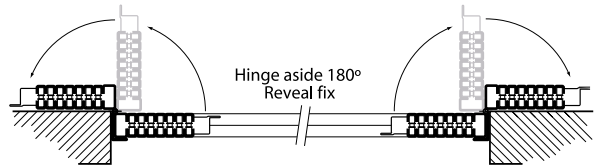
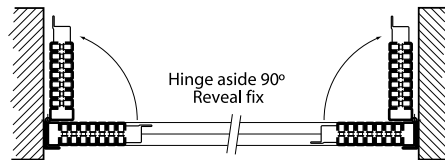

Please Note: Hinge aside gates can be supplied with either a folding or lift out bottom track but cannot be supplied with a fixed bottom track.

FOLDING TRACK AND REMOVABLE TRACK OPTION DETAILS

Single Sash Folding Track Option

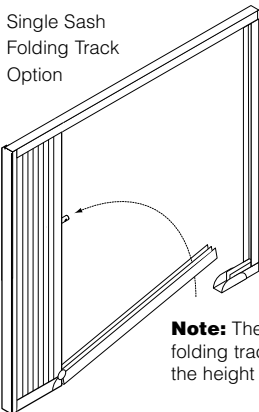

Note: Folding tracks with a length of 600mm or more are supplied with a retaining pin as standard. This is located between 488mm and 568mm from the ground regardless of track length.
The retaining pin projects 60mm beyond the lock post.

Note: The length of the folding track cannot exceed the height of the gate

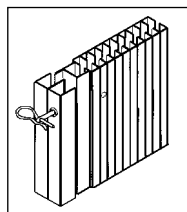

Bi-parting Sash Folding Track Option

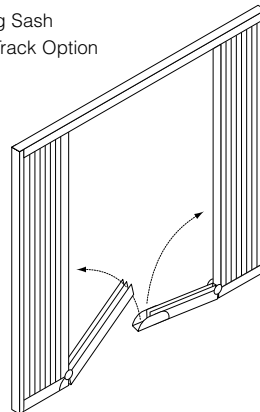

Lift Out Bottom Track Option

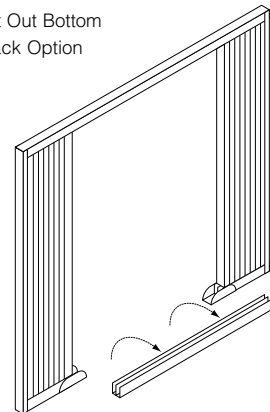



-  Commercial
-  Retail
-  Counter & Cabinet
-  Domestic

Your Specialist Distributor: